

KONIC

USER' S MANUAL **LED TV SET**

MODEL:KUD65MD686AS2

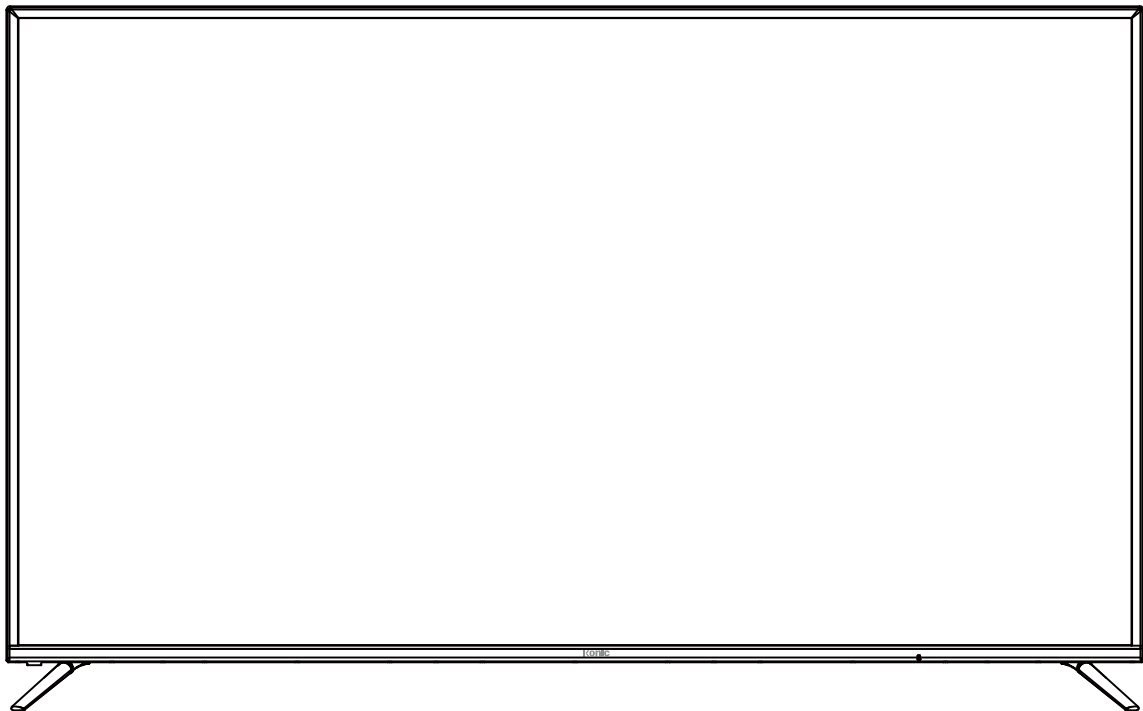

Important Safety Instructions and Maintenance

Important Safety Instructions

CAUTION

Risk of electronic shock, do not open.
Do not attempt to service this product yourself as opening or removing covers may expose you to dangerous voltage or other hazards.
Refer all servicing to qualified service personnel.

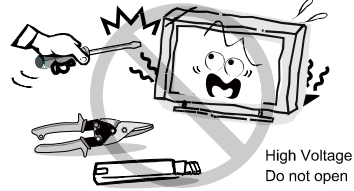

If the following problems occur:
Turn off the TV set and unplug the AC power cord immediately if any of the following problems occur.
Ask your dealer or service centre to have it checked by qualified service personnel

When:

- AC power cord is damaged.
- Poor fitting of AC power outlet.
- TV set is damaged by being dropped, hit or having something thrown at it.
- Any liquid or solid object falls through openings in the cabinet.

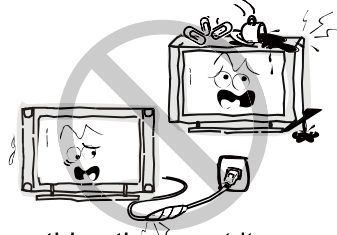

To reduce the risk of fire or electric shock, do not expose this product to rain or moisture.
The apparatus shall not be exposed to dripping or splashing and no objects filled with liquids, such as vases, shall be placed on the apparatus.



The screen and cabinet get warm when the TV is in use. This is not a malfunction. In case of smoke, strange noise or strange smell from the unit:

- Turn off the power switch immediately;
- Disconnect the power plug from the power outlet;
- Contact your dealer or service centre. Never attempt to make repairs yourself because this could be dangerous.

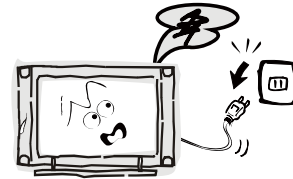

Never push objects of any kind into the set through the cabinet slots as they may touch dangerous voltage points or short-circuit parts that could result in a fire or electric shock. Never spill liquid of any kind on the set. Use special caution in households where children are present. The apparatus is not suitable for children under 3-year to operate.



Do not overload wall outlets, extension cords or adaptors beyond their capacity, this can result in fire or electrical shock.

Power-supply cords should be routed so that they are not likely to be walked on or pinched by items placed upon or against them, paying particular attention to cords at plug end, adaptors and the point where they exit from the appliance. The mains plug is used as the disconnect device. It shall remain readily accessible and should not be obstructed during intended use. Make sure to plug the power cord in until it is firmly inserted. When removing the power cord, make sure to hold the power plug when pulling the plug from the outlet, do not pull the plug out by the wire. NEVER touch the plug or power cord with wet hands. To disconnect the apparatus from the mains power, the plug must be pulled out from the mains socket, therefore make sure the mains plug is always easily accessible.

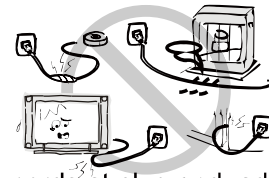

Important Safety Instructions and Maintenance

Important Safety Instructions

Do not push or scratch the front filter, or place any objects on top of the TV set. The image may be uneven or the screen may be damaged.

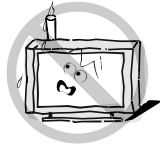

To avoid the fire, no naked flame source, such as lighted candles, should be placed on the apparatus.

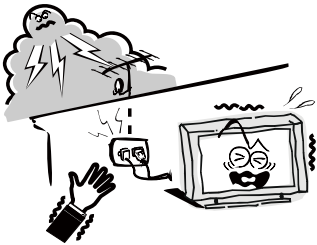

An outside antenna system should not be located in the vicinity of overhead power lines or other electric light or power circuits, or where it can fall into such power lines or circuits. When installing an outside antenna system, extreme care should be taken to keep from touching such power lines or circuits as contact with them might be fatal. Ensuring the television is not overhanging the edge of the supporting furniture.



When not in use

If you will not be using the TV set for several days, the TV set should be disconnected from the AC mains for environmental and safety reasons. As the TV set is not disconnected from the AC power when the TV is turned off at the standby switch, pull the plug from the AC power outlet to disconnect the TV completely. However, some TV sets may have features that require the TV set to be left in standby to function correctly. In the case of lightning, unplug the TV set from the outlet immediately. Never touch the antenna wire during lightning.

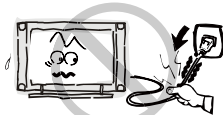

Do not pull the plug out by the wire;
Never touch the plug with wet hands.



Excessive volume from earphones and headphones can cause hearing loss.

Installation

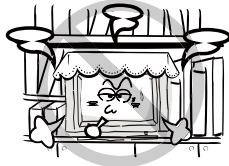

The ventilation should not be impeded by covering the ventilation opening with items, such as newspapers, tablecloths, curtains, etc.
At least 10 cm space should be left around the apparatus for sufficient ventilation.

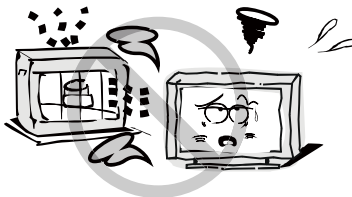

The product should be situated away from heat sources such as radiators, heat registers, stoves, or other products (including amplifiers) that produce heat. Place the apparatus in such a position that the screen is not exposed to direct sunlight. It is best to have soft indirect lighting while watching and avoid completely dark environments and reflection from the screen as these may cause eye fatigue.
Keep the TV set away from any equipment emitting electromagnetic radiation.

Important Safety Instructions and Maintenance

Installation

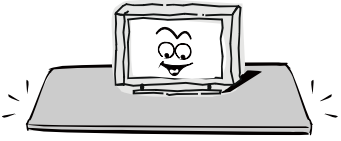

Do not place the set on an unstable cart, stand, table or shelf. The set may fall, causing serious personal injury as well as damage to the product. Use only with the cart, stand, tripod, bracket, or table specified by the manufacturer, or sold with the apparatus. An appliance and cart combination should be moved with care. Quick stops, excessive force, and uneven surfaces may cause the appliance and cart combination to overturn.



Do not place this apparatus near water, for example, near a bath tub, wash bowl, kitchen sink, or laundry tub; in a wet basement; or a swimming pool; and the like;



When the TV being moved in from cold place, it needs some right time for dew inside unit evaporating fully before turn on the unit;

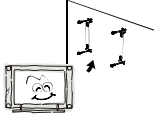

To prevent injury, this apparatus must be securely attached to the floor/wall in accordance with the installation instructions.

LED Screen

Although the LED screen is made with high precision technology and 99.99% or more of the pixels are effective, black dots may appear or bright points of light (red, blue or green) may appear constantly on the LED screen. This is a structural property of the LED screen and is not a malfunction.

If the surface of the LED panel cracks, do not touch it until you have unplugged the AC power cord. Otherwise electric shock may result.

Do not throw anything at the TV set. The LED panel may break from the impact and cause serious injury.

Precautions When Displaying a Still Image

A still image may cause permanent damage to the TV screen.

Do not display still images and partially still images on the LED panel for more than 2 hours as it can cause screen image retention. This image retention is also known as "screen burn". To avoid such image retention, reduce the degree of brightness and contrast of the screen when displaying a still image. Watching the LED TV in 4:3 format for a long period of time may leave traces of borders displayed on the left, right and centre of the screen caused by the difference of light emission on the screen. Playing a DVD or a game console may cause a similar effect to the screen. Damages caused by the above effect are not covered by the Warranty.

Displaying still images from Video games and PC for longer than a certain period of time may produce partial after-images. To prevent this effect, reduce the 'brightness' and 'contrast' when displaying still images.

Cleaning



Cleaning and handling the screen surface and cabinet. Disconnect the unit from the AC outlet before cleaning. To remove dust, wipe gently with a soft, lint free cloth. If required use a slightly damp cloth.



MAINS PLUG

Wipe the mains plug with a dry cloth at regular intervals. Moisture and dust may lead to fire or electrical shock.

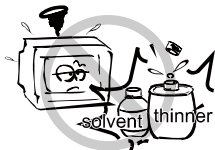

Use care not to subject the TV's surfaces to detergent. (A liquid inside the TV could lead to product failure, fire or electrical shock.)

Use care not to subject surfaces to bug repellent, solvent, thinner, or other volatile substances as this may deteriorate the surface and finish of the cabinet.

Contents

General description	5
Specifications	6
Overview	7
External connection	8
Remote Control	9
Menu Operation	11
External connection	35
Trouble shooting	35
Picture defects and countermeasures	36

General Description

Feature:

- Auto tuning and fine tuning
- One YPbPr input socket
- Three HDMI input socket (CEC ARC at HDMI2)
- One composite AV input socket
- One COAXIAL output socket
- Support USB
- Headphone
- Wide range voltage input

Specifications

Specifications:

Description	KUD65MD686AS2
Display Screen Type	Color active matrix LED display
Display size	65" Diagonal(max.)
The maximum resolution	3840x2160
Power supply	110-240V~ 50/60Hz
TV receive system	NTSC:M;PAL: M/N;DVB-T/T2/S2
Frequency range	48.25~863.25MHz
Video in	PAL/NTSC
Antenna input impedance	75Ω
Sound output	2x8W
Power supply for remote controller	DC 3V (Two AAA size batteries)
Power consumption	165W
HDMI support resolution	480I/P 576I/P 720P 1080I/P 2160P
Operation environment temperature	0°C-40°C

Note: Due to TV may be used with different display screen, weight marked in this user's manual or in packaging box are subject to change without notice.

Overview

The buttons on the lower-right panel control your Tv's basic features, including the on-screen menu. To use the more advanced features, you must use the remote control.

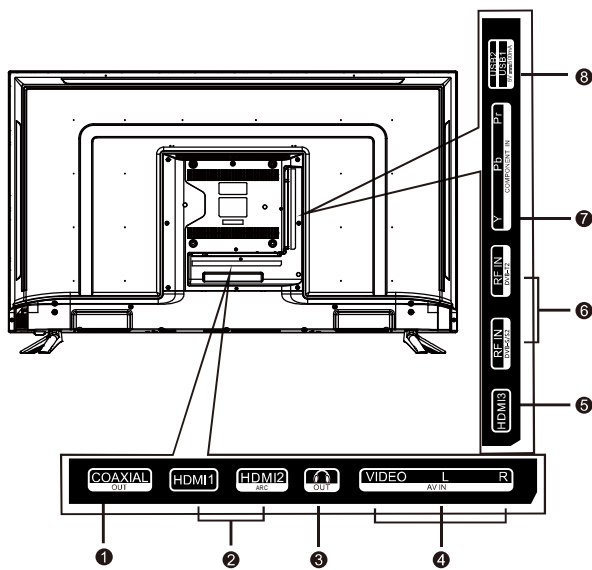
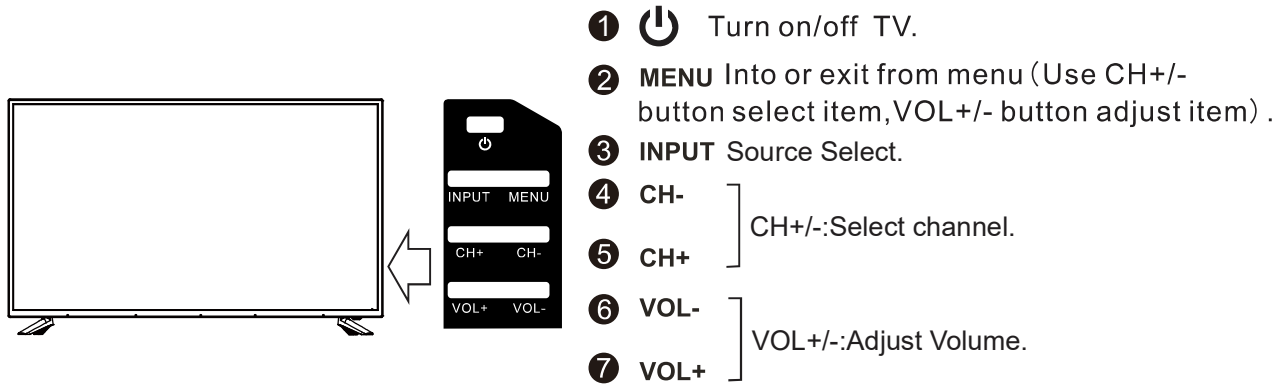

- 1 **COAXIAL**: Connect Coaxial out.
- 2 5 **HDMI 1/HDMI 2/HDMI 3**: Connect to the HDMI jack of a device with an HDMI output.
- 3 **EARPHONE OUT**: Audio output for external devices.
- 4 **AV IN** : AV input.
- 6 **RF IN**: Connect to an antenna or satellite antenna.
- 7 **YPbPr**: Connect Component video
Connect composite video.
- 8 **USB**: Connect to USB flash driver to play supported multimedia content.

External connection

Before attaching/detaching the stand, make sure to turn off the TV.
-Before performing work spread cushioning over the base area to lay the LED TV on.
This will prevent it from being damaged.

Stand installation instruction

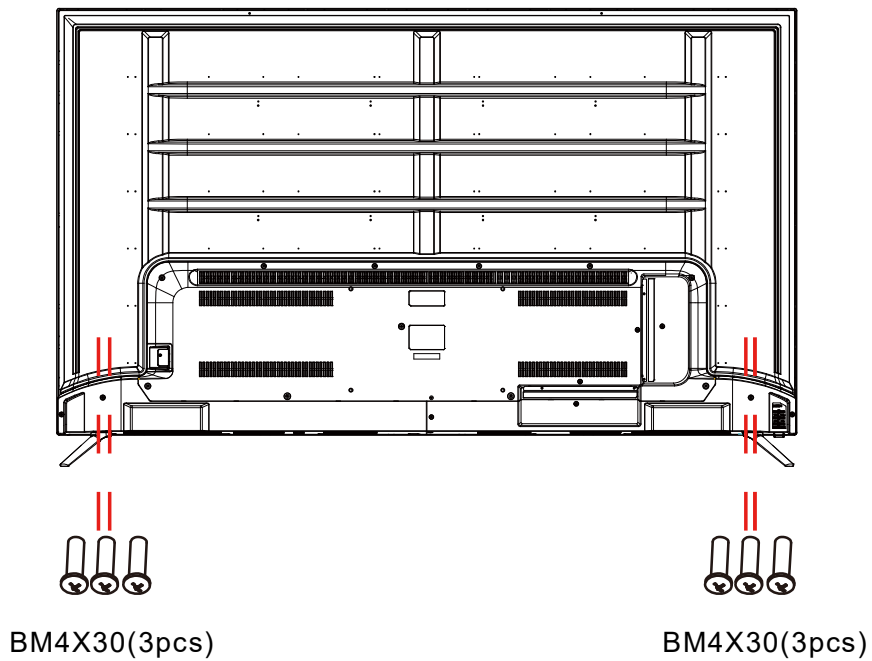

Remote Control

REMOTE CONTROL OUTLOOK & FUNCTION KEY DEFINITION

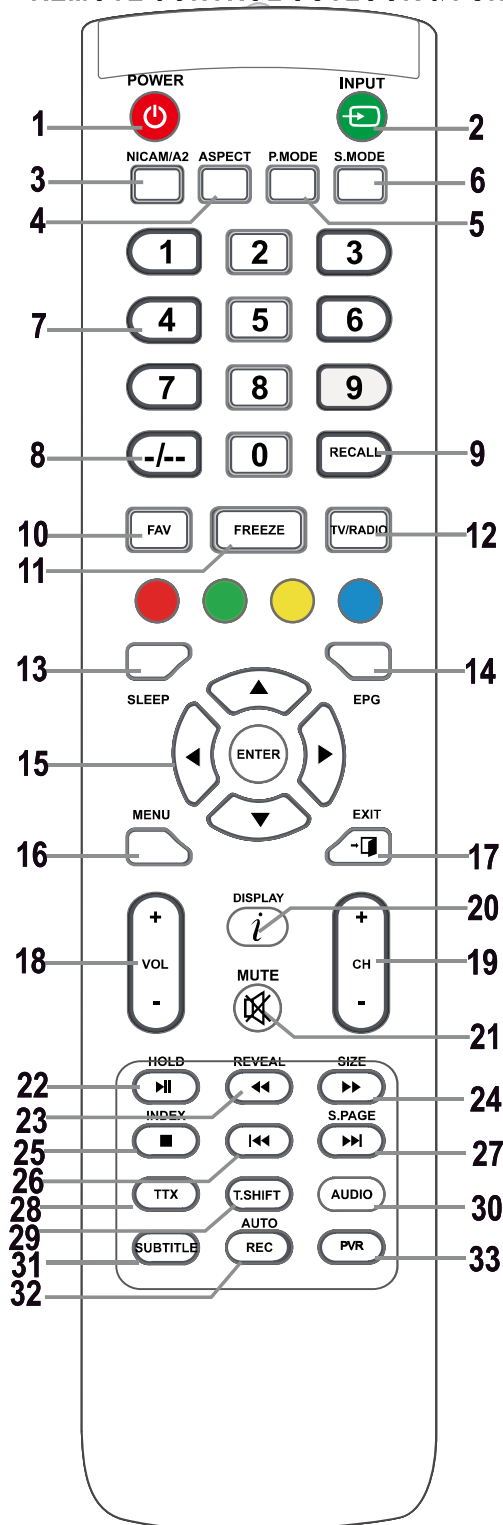

1. POWER button

Turns the television on from the stand-by mode.

2. INPUT button

Press to select the desired input.

3. NICAM button

NICAM/A2 input or output.

4. ASPECT button

Page aspect ratio selection, e.g. 16:9, Zoom, Auto, 4:3

5. P-MODE button

Press to select a picture mode.

6. S-MODE button

Press to select a sound mode.

7. Numerical buttons 0-9

Press 0-9 to directly select a TV channel while watching the TV. In teletext mode enter the page number, etc.

8. -/-- button

It is used to enter channel numbers with various digit counts, e.g. for 1 – 11 – 111.

9. RECALL button

Button for switching to the previously watched channel.

10. FAV button

Press in the TV mode to enter/exit the favourites menu.

11. FREEZE button (freeze)

Freeze the picture

12. TV/RADIO button

Switching between the television and radio modes.

13. SLEEP button

Set the automatic shut off time for the television.

14. EPG button

Press to show/hide the electronic program guide.

15. ////ENTER buttons

Used for navigating in a menu on the screen and for setting up the television according to your preferences.
ENTER button

It is used to enter / exit the Channel list menu. (Only DTV/ATV)

16. MENU button

In TV mode, it displays the LCD television's main menu.

17. EXIT button

Function for exiting a menu or a screen.

18. VOL +/- buttons

Press to increase/decrease the volume.

19. CH +/- buttons

Press to switch between individual channels.

20. DISPLAY button

Button for displaying the source and information about channels.

Remote Control

21. MUTE button

Press to mute the sound. Press it again to renew the sound or press VOL +.

22. HOLD/▶II button

HOLD button: hold the current display

In the MEDIA mode: Playback/pause or start a time shift recording.

23. REVEAL/◀◀ button

REVEAL button: Press REVEAL to display or hide hidden teletext information (depends on the broadcast).

◀◀ button: fast rewind

24. SIZE/▶▶ button

SIZE button: Press SIZE to change the size of the screen in the MEDIA mode.

▶▶ button: fast forward .

25. INDEX/■ button

INDEX button: call up a teletext content page.

■ button: Stop recording / playback.

26. I◀◀ button

In the MEDIA mode: skip to the previous track

27. S.PAGE/▶▶I button

S.PAGE button: Press S.PAGE to enter a teletext subpage.

▶▶I button: skip to the next track .

28. TTX button

Turn teletext on or off.

Note: The teletext function is optional and the availability of buttons depends on the model.

Teletext information fully depends on the operator of the channel.

29. T.SHIFT button

It is used to start recording with a time shift (i.e. time shift). Function is only available in the DTV mode.

30. AUDIO button

DTV/MEDIA mode: select a background sound, if available.

ATV mode: select a sound mode: Stereo/Dual I/II/Mono.

Other sources: select the left / right channel

31. SUBTITLE button

Button for showing / hiding subtitles in the bottom part of the screen, if they are available.

32. AUTO / REC button

AUTO button: Used for automatic configuration in the PC mode.

REC button: Press to start recording. (only in the DTV mode.)

33. PVR button

It is used to enter / exit the PVR setting menu.

Note:

Remove battery during storage or when you are not using the device for a long time.

To control the device using the remote control, point the remote control at the device and then press the button with the required function. The maximum range of the remote control is about 5 meters with a deviation of up to +/- 30° from the perpendicular direction to the reception sensor of the remote control on the front side of the device. The falling capacity of the batteries gradually reduces the remote control range. There must be no solid obstacles in the area between the remote control and the device when the remote control is being used.

During standard use the lifetime of batteries in the remote control is about 1 year.

When the effective range of the remote control is substantially reduced, or when there are problems with its use, change both the batteries in the remote control. If you will not be using the remote control for a longer period of time, take out both batteries from it – in this way you will prevent potential damage caused by their leakage.

Avoid strong impact of light (e.g. sunlight or light from strong fluorescent/saving sources) which can reduce the effectiveness and reliability of IR remote control.

Menu Operation

TV MENU TV

Press input button and start changing settings.



Channel

***Under the source of “DVB-T”**



Menu Operation

* Auto tuning

Select option of Auto Tuning under the up and down button. After pressing OK button, the screen will appear the country list and you are able to choose what you want with arrow button. Press OK button to start auto channel tuning and the screen show the programs number.

* DVB-T Manual tuning

Select channel number with left and right button. Then press OK button to start manual tuning.



● Program Edit



After choosing “program edit” option, you can press relevant button to edit program. The red button can help you delete program and the green button is used to rename. You can press yellow button to move and press blue button to skip program. When you press O, all programs can be deleted.

Menu Operation

- LCN

Through the up and down button to select \"LCN\" option, then can use left and right buttons to open or close the logical channel number.

- Software update

Please prepare USB and relevant update files before software update. Then insert USB and choose this option. You should do according to system hint and remember not to pull out USB before finishing software update.

- ATV Manual Tuning

Select the \"ATV manual station search\" option and press OK to enter the next interface. After setting the sound mode and other options, select the search function through the left and right button.

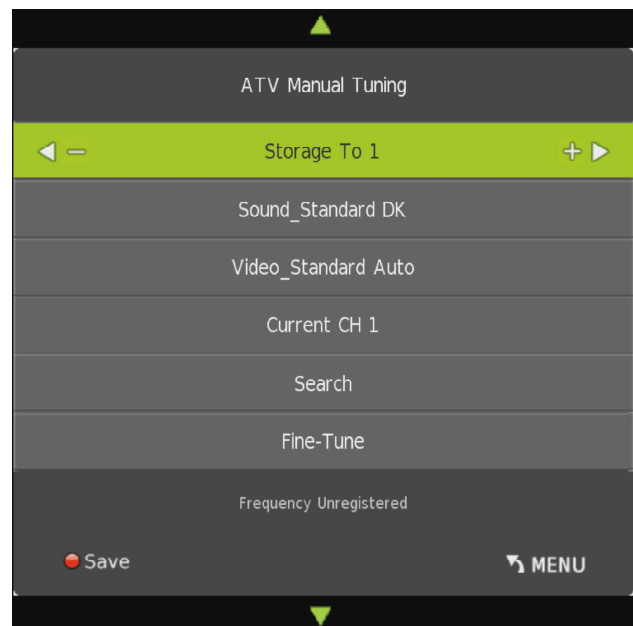

Menu Operation

*Under the source of satellite



Auto Tuning



Photo1

(1) Select option of Auto Tuning under the source of satellite and there will be different operations you should know. As shown in photo1, you can press OK to appear list and choose one of satellite signal name under circumstance of highlighted satellite option.

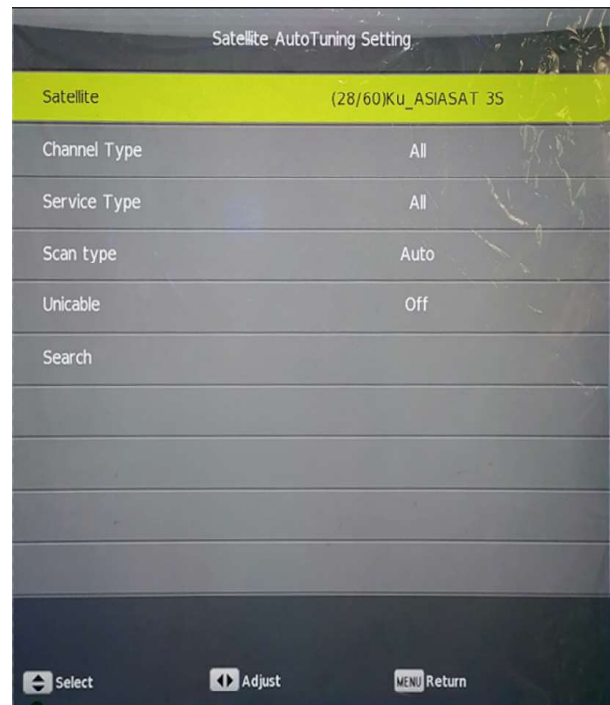

Photo2

(2) The system provides three channel types including free, scramble, all. You can set the service type as DTV/Radio/All and scan mode can be modified to preset/audio/blind screen with right button. Click word of search and auto tuning can start.

Menu Operation

* Satellite auto tuning setting

The Specific parameter setting includes userband/SRC Add. , frequency and position.
The userband have many options, such as 1/0, 2/1 , 4/3, 7/6. The range of frequency swing and you can set according to your need. The position can change to A/B

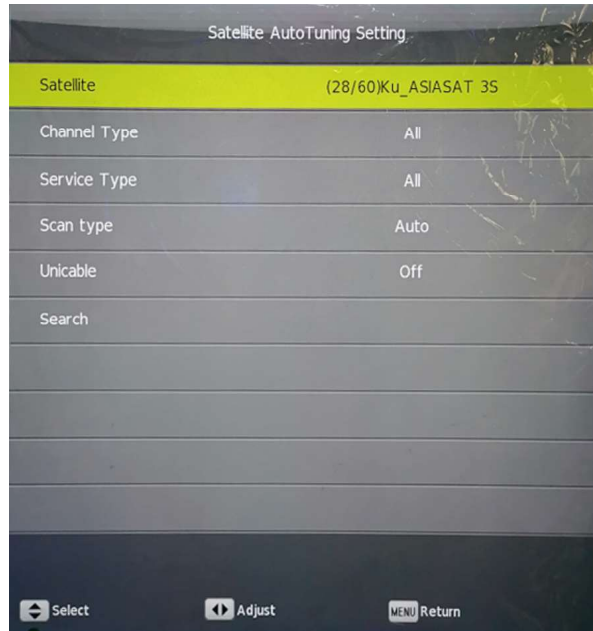

● DVB-S manual tuning

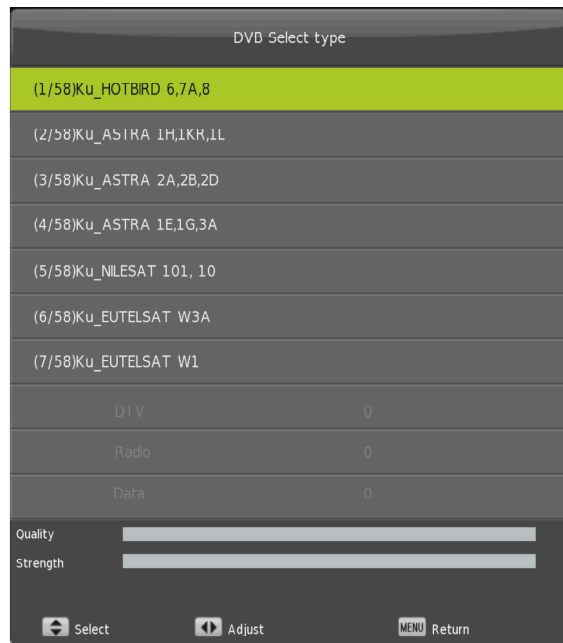
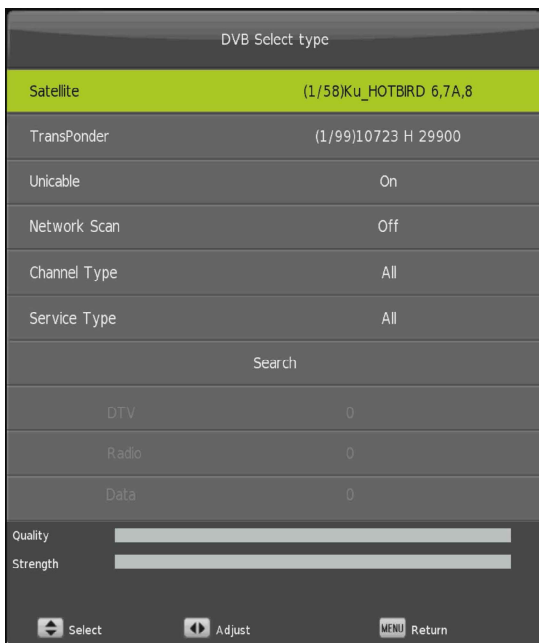

Press OK button to show satellite name list and choose one when TV is in main manual tuning.
The system give you three service type including free, scramble, all .Please note that you are able to open/close network scan.
The unicable setting under DVB-S manual tuning is same with auto tuning.

Menu Operation

❖ Motor

First choose one satellite signal and press red button to set motor . You can modify specific direction for move auto ,move continue , move step.In this main interface,Goto position and preference can be set after pressing OK button. Please pay attention that the GotoX can change in the Diseqc1.3

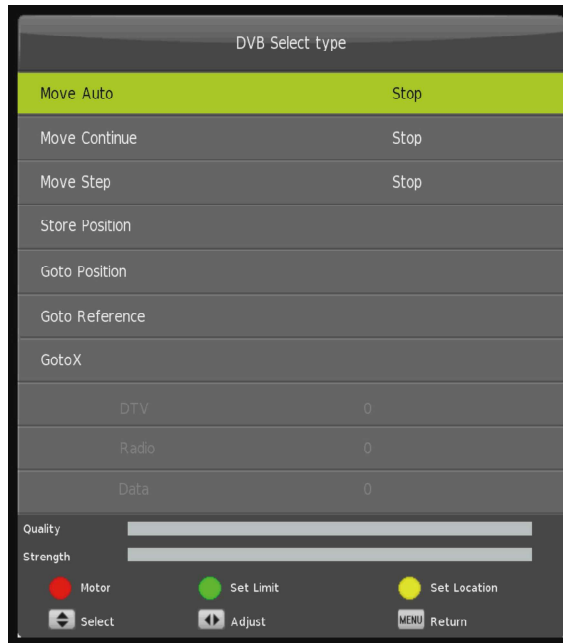

❖ Set limit, location

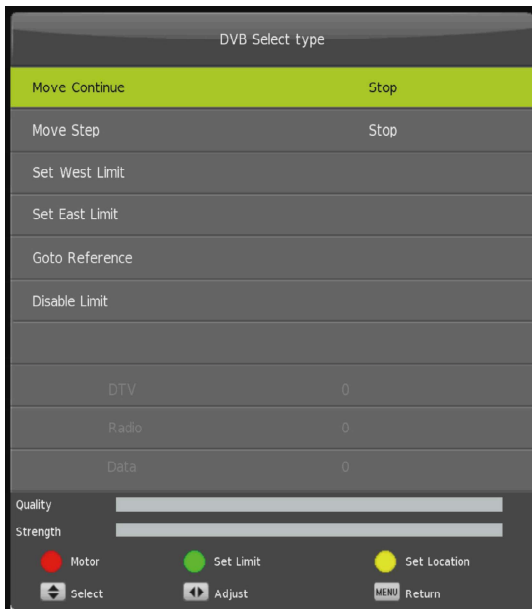

Choose one satellite signal and press green button to set limit. Not only you can set east and west limit, but also you have access to disable limit. If you press yellow button, you are able to set location. When you choose location by manual, other settings can not be modified. The system provides many locations for you. After

Menu Operation

you choose specific location , you have chance to set longitude angle.

Note: you also can set limit and location in the satellite edit interface.

● Satellite edit

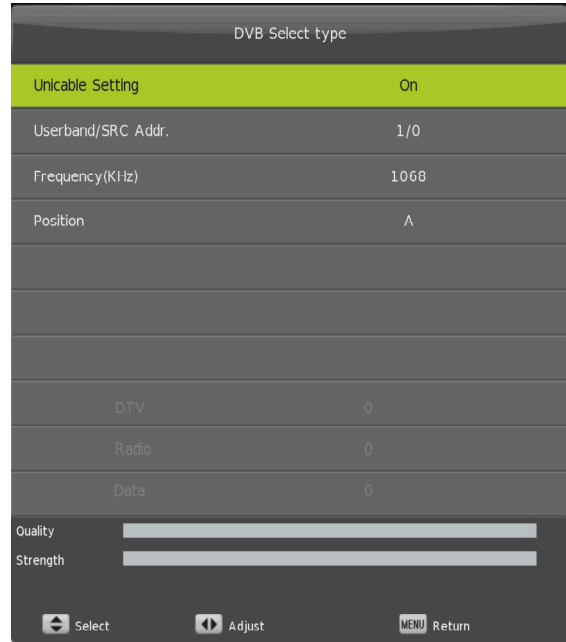
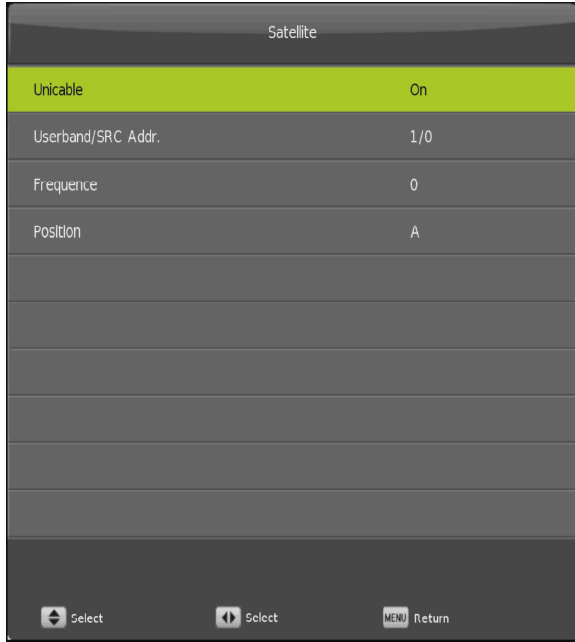

- (1) Choose one of satellite signal list and press OK button to enter setting interface. The orbit positions you can select are just 019.2E and 019.2W. For LNB type, the system provides many options to fit your needs. You can open one or close all about Diseqc. Diseqc1.0 can switch from LNB1 to LNB4. Diseqc1.1 can support LNB from 1 to 16. As motor, you should choose Diseqc kind and then set move position. You are able to move audio from east or west. If you don't need it, you can set as stop. The unicable setting is the same with the circumstance of DVB-S auto tuning.
- (2) You should input satellite name, symbol rate, Polarity after pressing yellow button. Then you press OK button and the satellite addition can successfully finish.

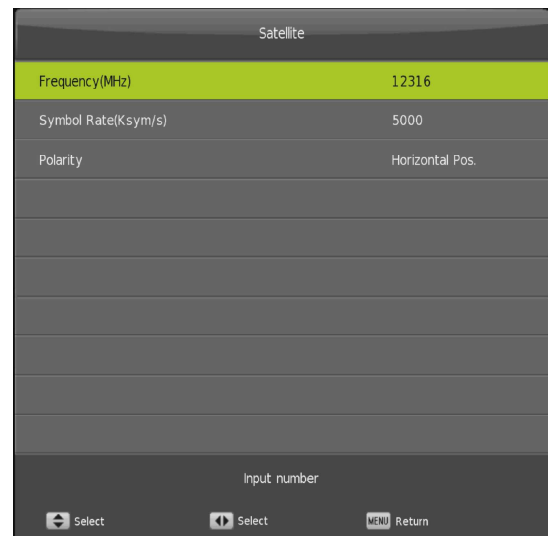

❖ DTH Tuning

On the initial scan the receiver shall perform an automatic scan based on the Freeview NIT information found on the “home transponder” at 12.483GHz. It shall find all transport streams and services referenced within the NIT and shall tune in to the correct DVB structure, channel coding, modulation. However, the receiver shall only display services that are referenced in the regional Freeview BAT selected by the user during initial setup. Services not listed within the regional BAT shall not be displayed. See section 5.8 for more information. In addition to an automatic search it shall be possible to perform a manual search where the tuning parameters are entered manually. New channels shall be added to the service list. No duplicated channels, nor encrypted channels shall be displayed in the service list.

Picture

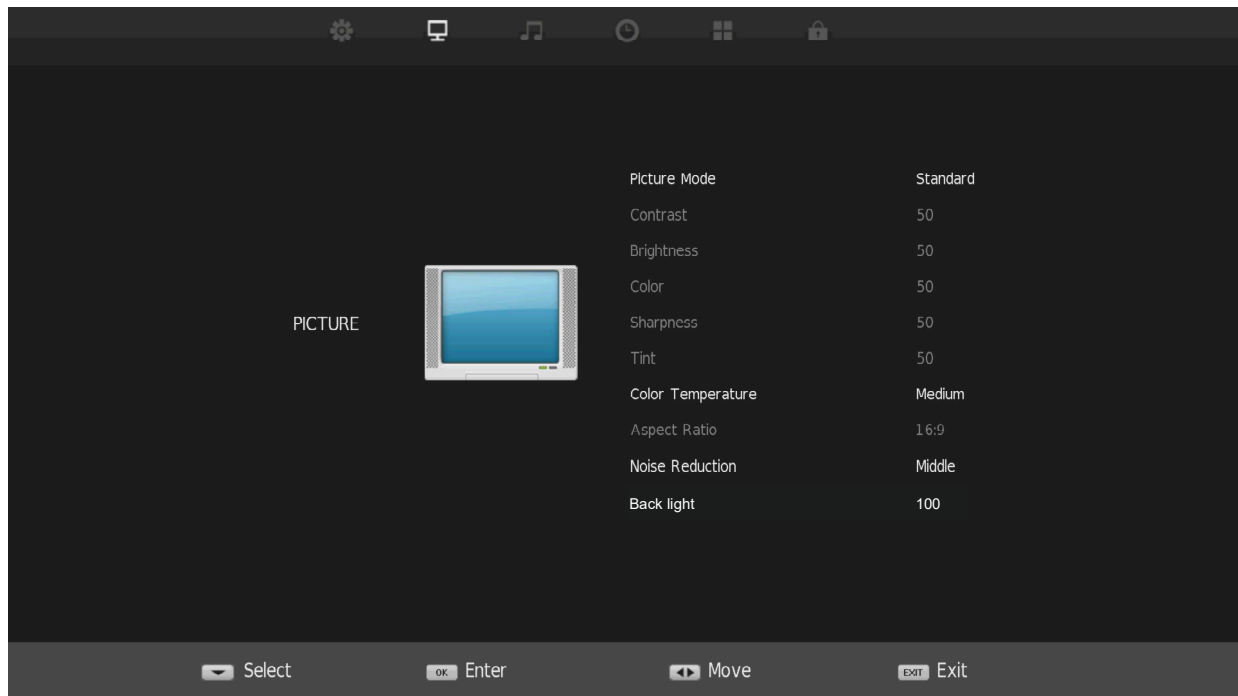

- **Picture Mode**

Choose the picture menu with left and right button. Then the up and down arrows can be used to select this item. The picture mode can be switched to **standard/dynamic/mild/user** through right button.

- **Noise Reduction**

Select the option of noise reduction by the above-mentioned way, then change its setting with left and right button. The color temperature can be **low/middle/high**

- **Color temperature**

Select the option of color temperature by the above-mentioned way, then change its setting with left and right button. The color temperature can be **cool, warm, user mode**.

- **Aspect Ratio**

You can select **ZOOM1, ZOOM2, 16:9 or 4:3** with left and right button when the option of Aspect Ratio is picked.

- The value of These options including contrast, Brightness, sharpness, saturation can adjust with arrow button only in the user mode.

Sound

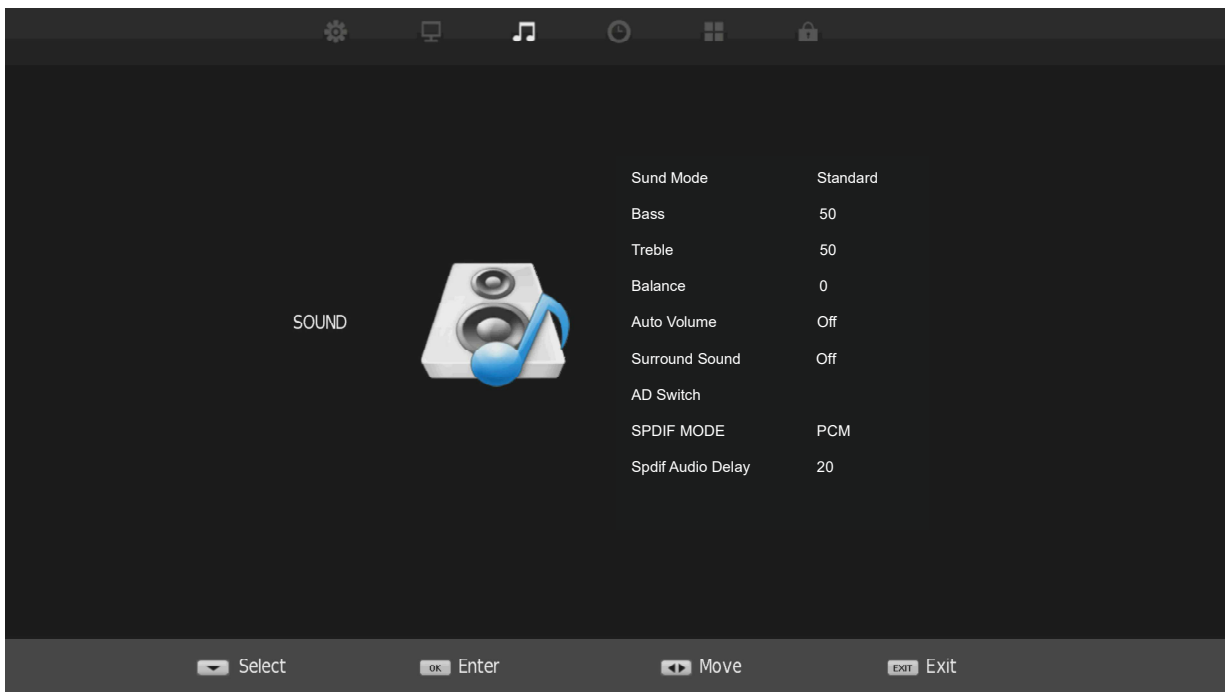

- Sound mode

Choose the sound menu with left and right button. Then the up and down arrows can be used to select this item. The sound mode can be switched to **music/movie/sports/stand/user** with left and right button.

- balance

With the up and down button, the option of balance can be selected. Then its value will change by left and right button.

- Auto volume, Surround sound

Select the option of Auto volume and press OK button. Then the Auto volume can be open or closed by left and right button. This way suits the adjustment of surround

- The other mode

Only when the sound mode is user can you adjust items. Please choose the specific frequency and modify its value by right button.

Menu Operation

Time

- Clock

Select the “Clock” and press OK button to enter interface , you can adjust data, month, year and so on with left and right button.

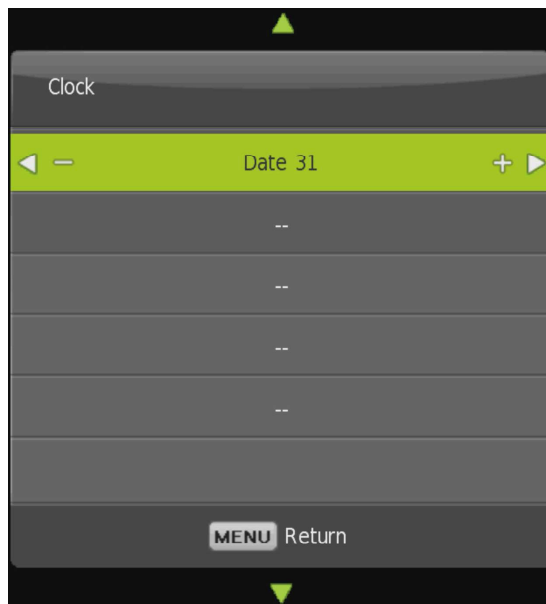
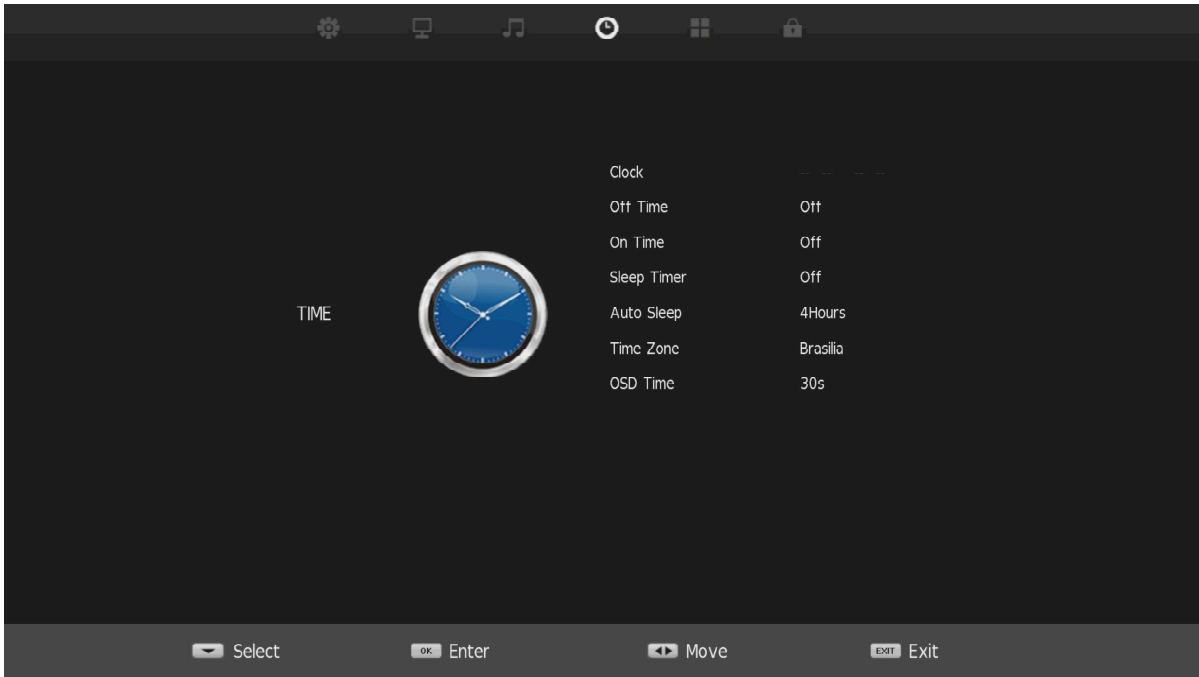

- Off time

Select the “off time” option and press OK button to enter interface. Then the left and right button can be used to adjust specific settings. For off time, you can choose Monday to Friday, Saturday to Sunday and other mode. The hour and minute for “off time ” can change at random.

Menu Operation



- On time

Select the “on time” option and press OK button to enter interface at left. Then the left and right button can be used to adjust specific settings. For off time, you can choose Mon. ~Fri.,Sat.~Sun and other mode. The hour and minute can change at random.

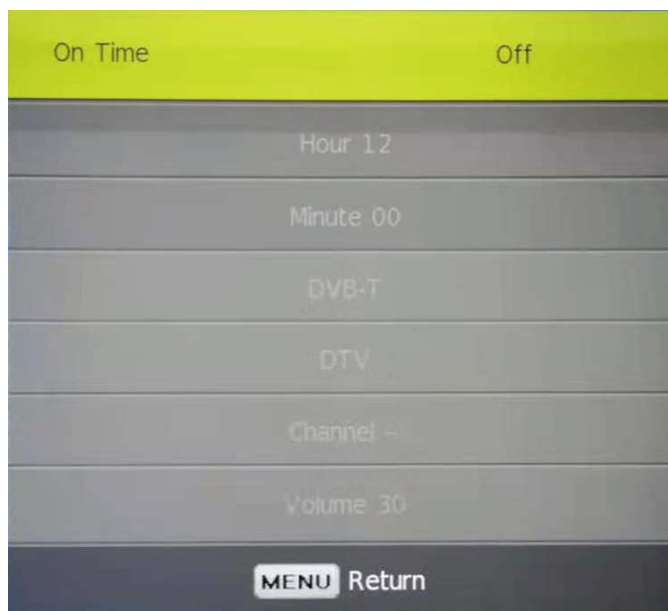

Menu Operation

- Time Zone

Select option of time zone and press OK button to enter. There will appear list and you can choose one from it.



- Sleep timer

Choose option of Sleep timer and press right button to alter sleep timer value. The system provides specific values that the min. value is 10 minutes and max. value is 240 minutes.

- Auto standby

Choose corresponding 3/4/5 hours, if not operating the remote control and press the keypad, TV automatically after 3/4/5 hours standby, select OFF, shut down without automatic standby function operation.

- OSD timer OSD

Select "OSD time" option, and right click to modify OSD time, the minimum value is 5 seconds, the maximum is 30 seconds, and can be set to close.

Option



● Reset

After selecting the option of reset and pressing OK button, you can find a prompt box for confirming reset. Please note that the reset will influence your previous setting.

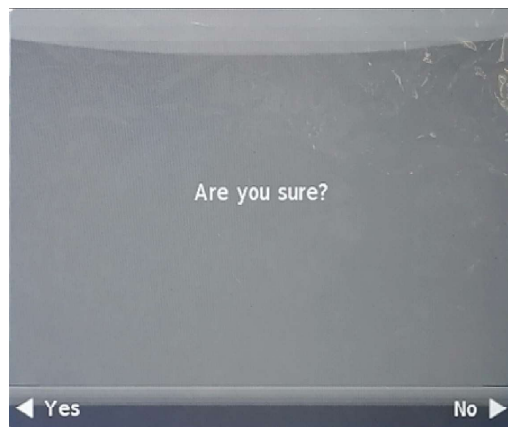

● Language

The language of OSD, Audio, Subtitle can be modified in this part. First, you should select the concerned option and press OK button to enter language list. The arrow button can help you choose what you want.

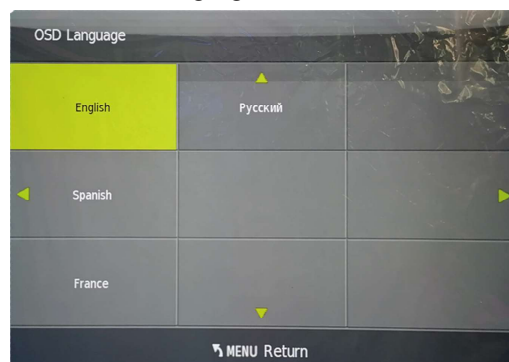

Menu Operation

● PVR File system

Before PVR, you should select address of PVR file and check PVR system. The PVR file system can set as FAT32/FAT 64. After setting PVR file system size, you are able to start PVR.

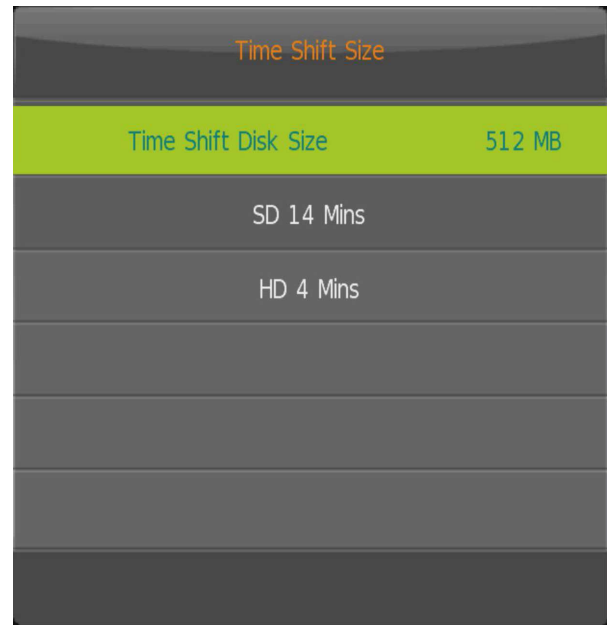
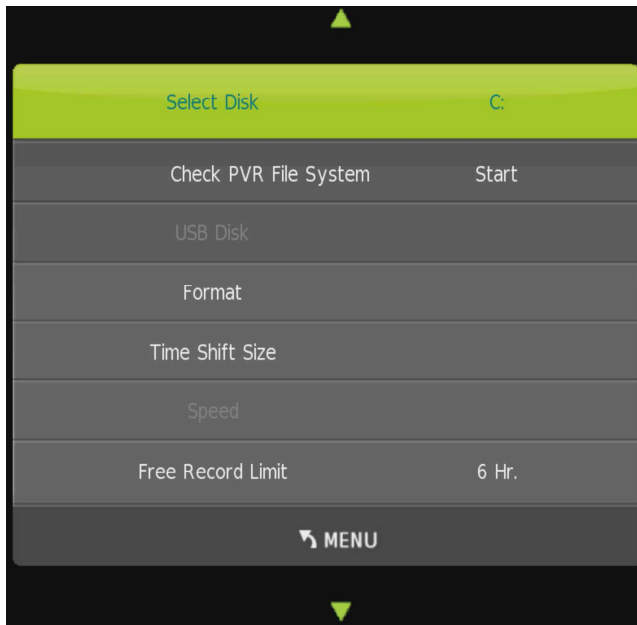

● HDMI CEC

The function of HDMI CEC can make your life intelligent and convenient. You can choose the function of HDMI ARC, Auto standby, Auto TV on, device control to your requirements.

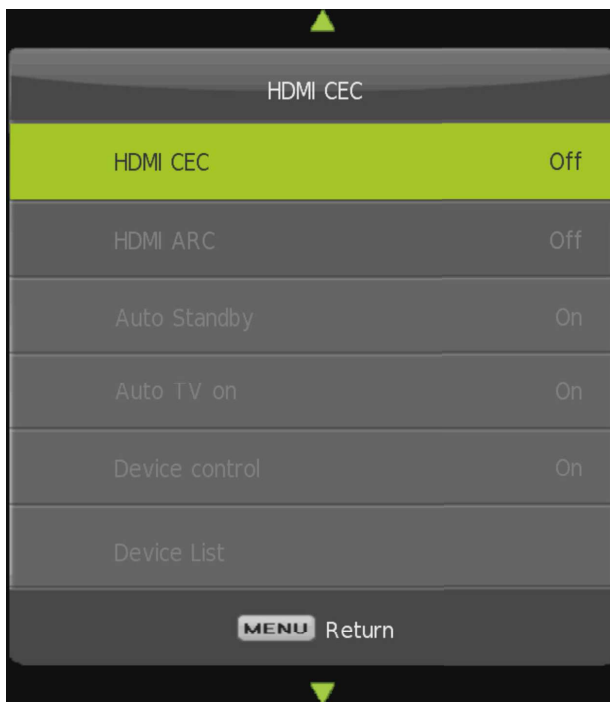

Menu Operation

● first time installation

Select first time installation item and press OK button to enter setting interface. The options you can modify include OSD language, country, and TV connection. You should press OK button to make sure your setting.

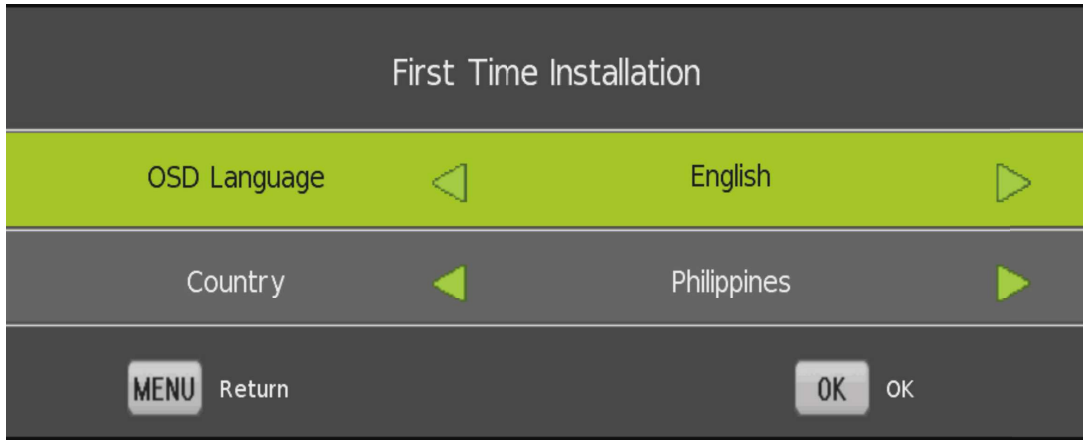

Lock

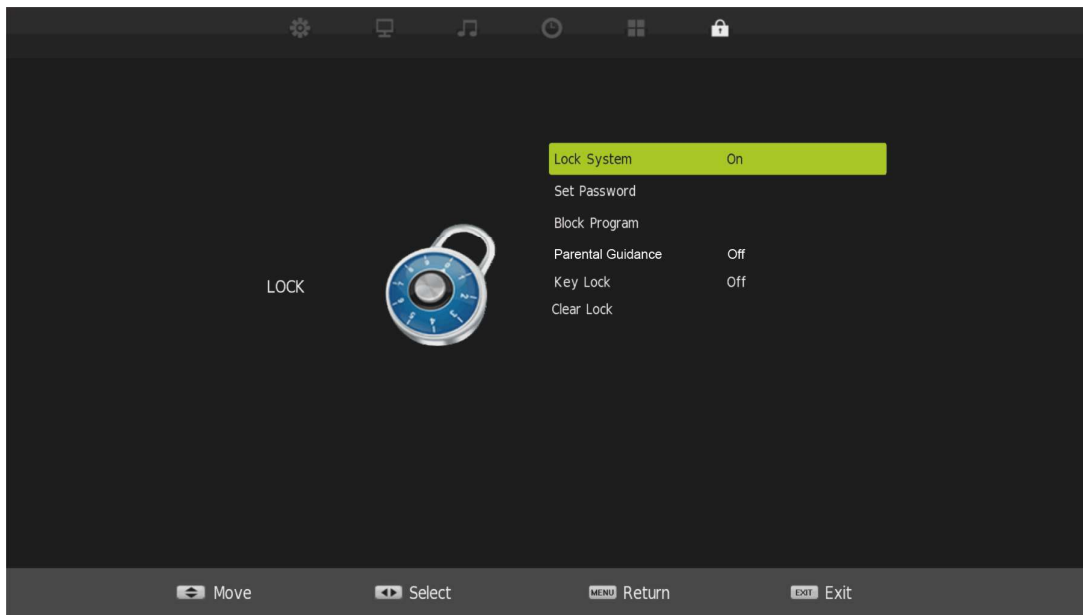

Choose the option of lock system with up and down button in the main interface. Then press OK button and there will appear prompt box for inputting password. After inputting original password of 0000, you are able to open lock system. More operations can be done when the interface shows as below:

Menu Operation

- Set password

When you want to change password, you can choose the option of set password. Please input correct old password and enter new password .The new password can be successfully after confirm.

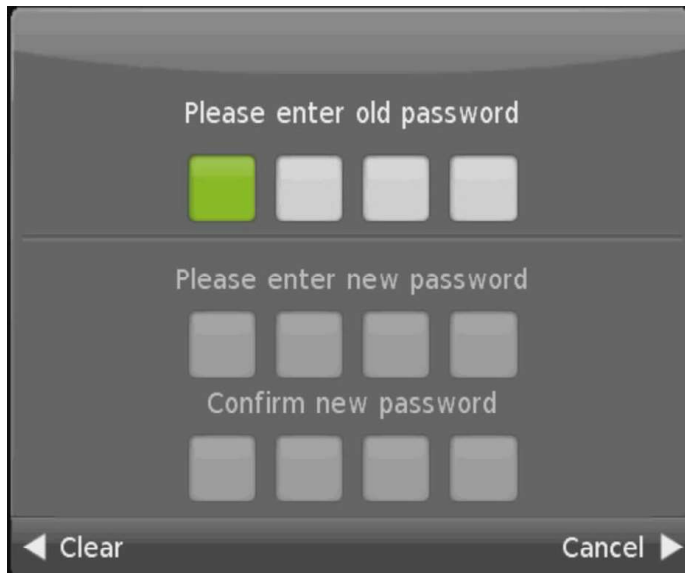

The image shows a dark gray dialog box for setting a password. It contains three sections of input fields:

- Please enter old password:** Four input boxes, with the first one highlighted in green.
- Please enter new password:** Four input boxes.
- Confirm new password:** Four input boxes.

At the bottom of the dialog, there are two navigation buttons: "Clear" on the left and "Cancel" on the right, both with arrowheads pointing outwards.

Menu Operation

- **Block program**

Choose the programs you don't like .Then press green button to lock these programs. Please press menu button if you want to go back previous interface.

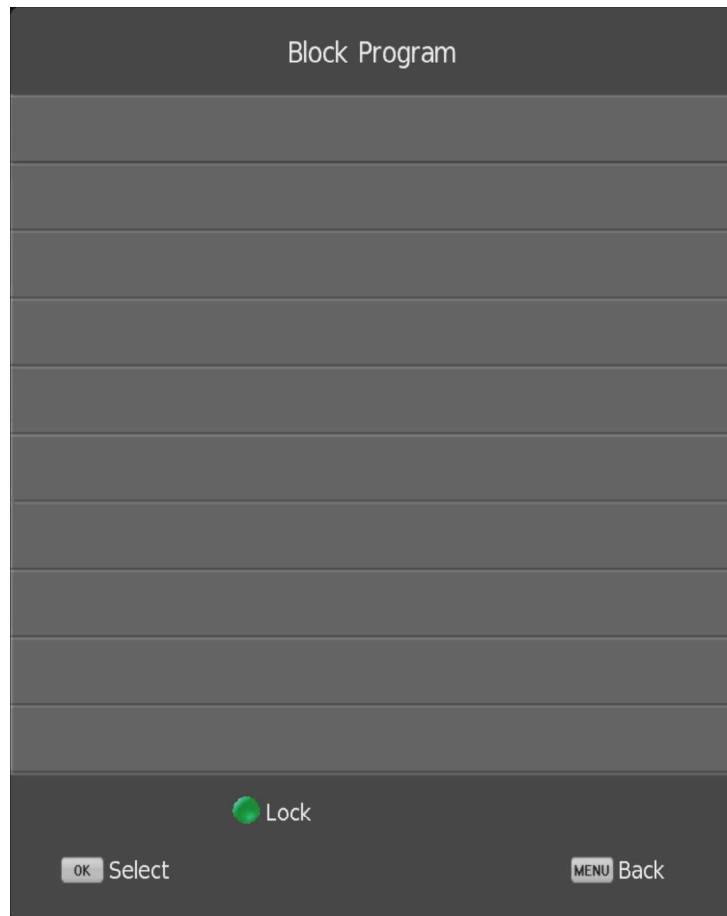

- **Parental guidance , button lock**

The grade of parental guidance ranges from 4 to 18.

Please pay attention that you can't do specific operation after opening button lock.

Menu Operation

- **Hotel mode**

Choose the option of source lock to enter source list. With left and right button, you are able to open or close input source.

Default source, default volume, Max volume can change through left and right button.

The above settings should be in accordance with your need.

Menu Operation

Media part

The media part consists of photo, music, film, text.

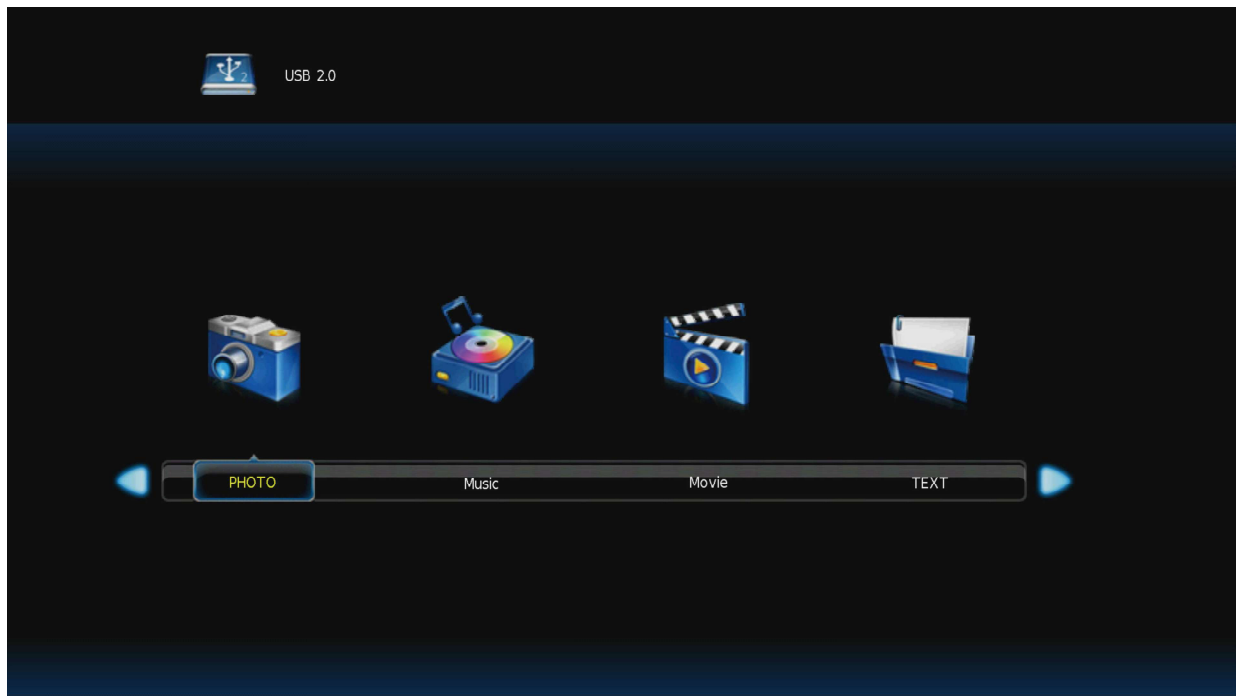

❖ Picture

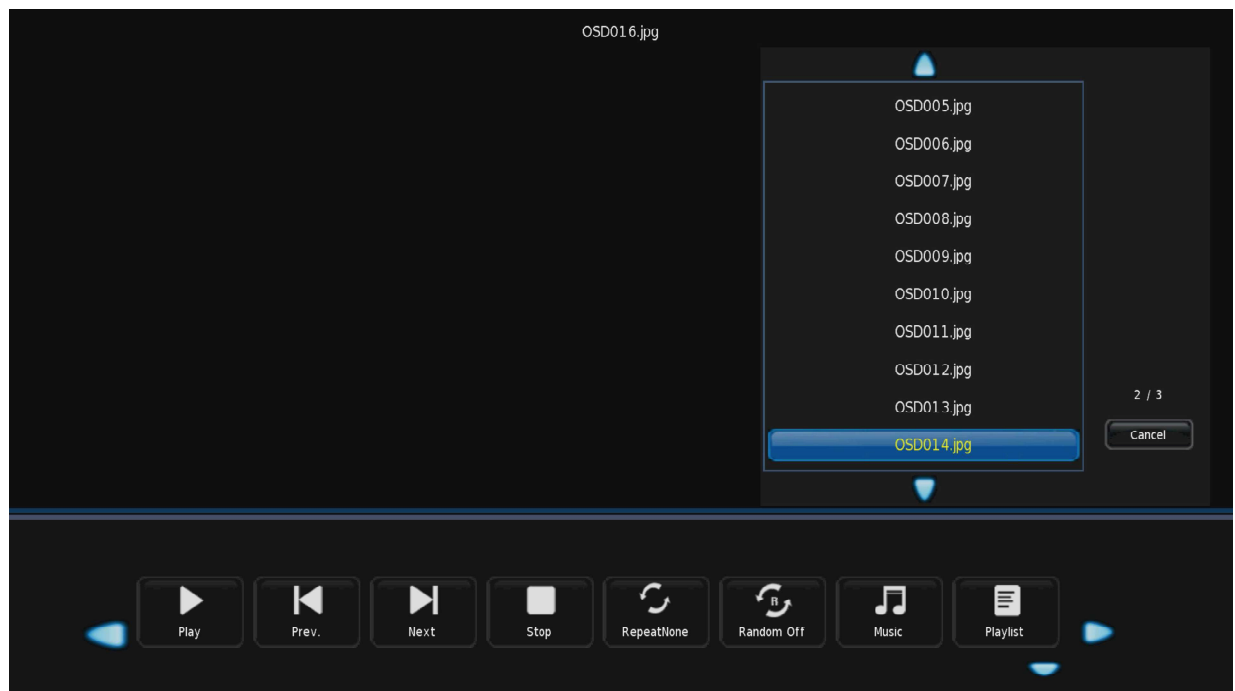

Menu Operation

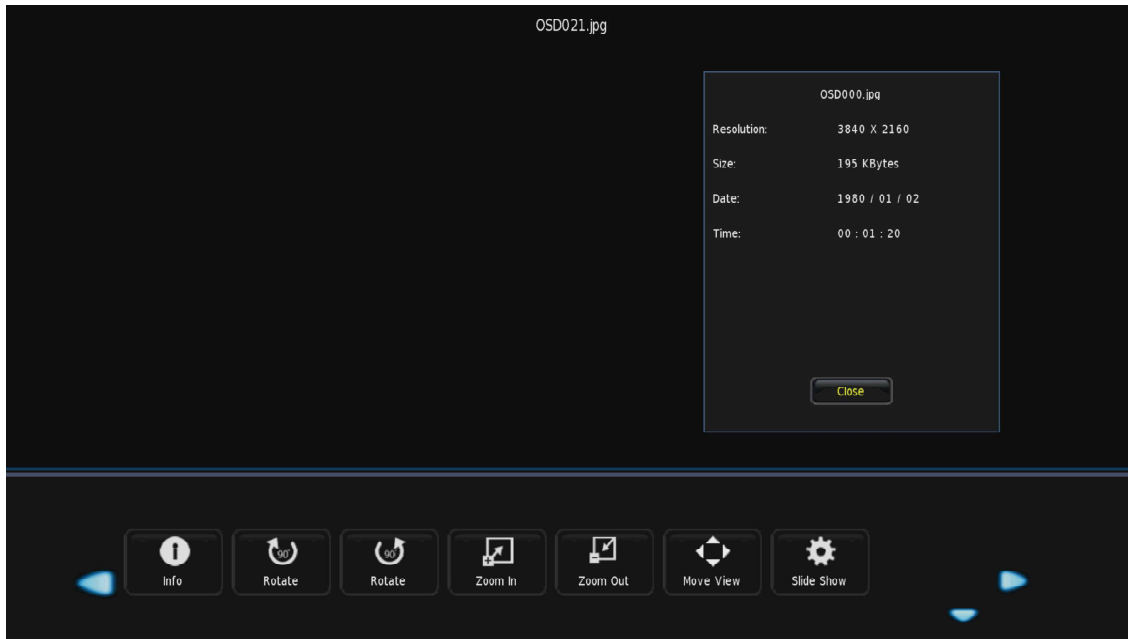

Pick the image of picture with left and right button. Then click “C port” and open concrete photo. Press OK button and there will appear image for further operation.

pause or display picture

show previous picture

show the next picture

stop play

single play or circulation

random play

background music

play list

Picture information including resolution, size, date, time

clockwise rotation

Menu Operation

counter-clockwise rotation

Zoom in to picture

Zoom out to picture

move view

Slide show

❖ Music



Pick the image of music with left and right button. Then click “C port” and open concrete song. Press OK button and there will appear image for further operation.

pause or display music

Fast backward

Fast forward

show previous music

show the next picture

Menu Operation

stop play

single play or circulation

set it as A or B

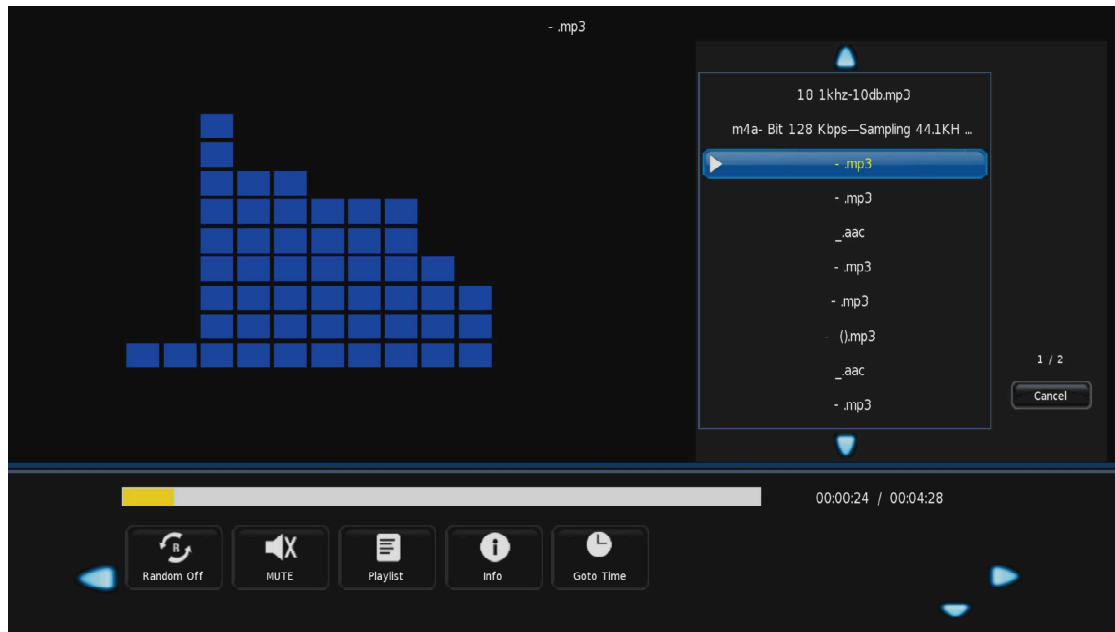

random play

Mute

play list

song information

Goto time for setting searching time

❖ Film

Pick the image of movie with left and right button. Then click “C port” and open concrete movie. Press OK button and you can do operation as following:

(1) Play or pause film ;(2) stop play ;(3) FB or FF; (4) Play previous film ;(5) Play next film ;(6)step forward; (7) show film information and so on.

Menu Operation

❖ Text

Pick the image of text with left and right button. Then click “C port” and open concrete text. Press OK button and there will appear image for further operation

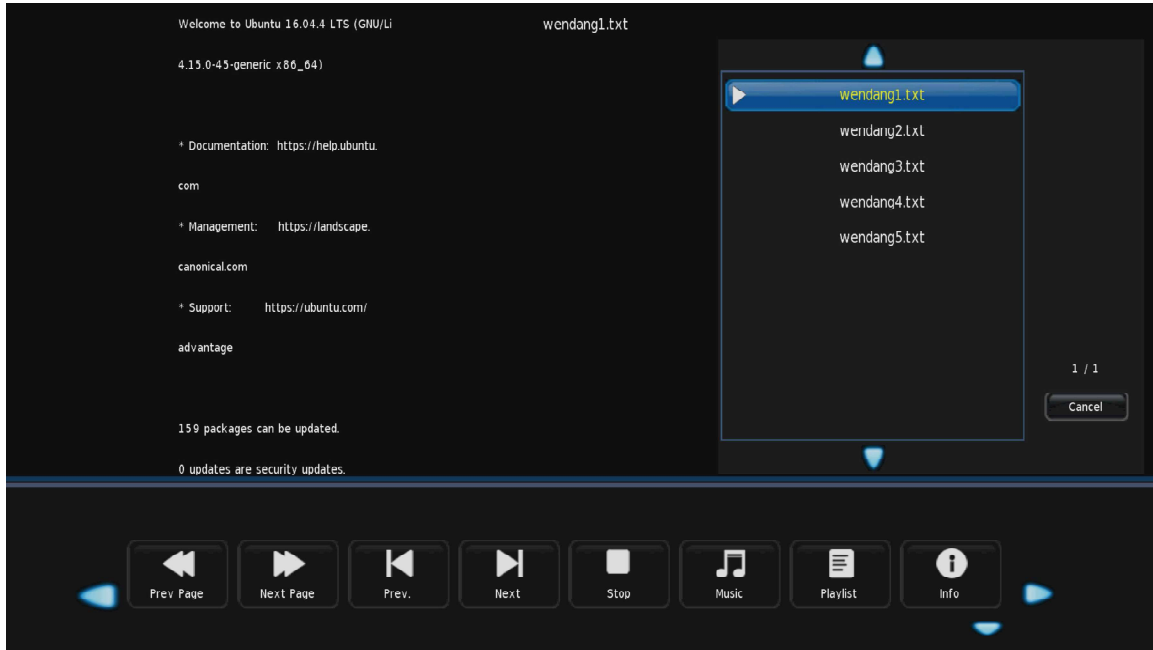

play previous page

play next page

Play previous text

Play next text

stop play

background music

text list

text information

USB MULTIMEDIA PLAYBACK FORMAT

Supernova Multimedia Spec. - Video
MPEG1/2,MPEG4,DivX 3.11,DivX 4.12,DivX 5.x,DivX 6, XviD,Sorenson H.263,H.264,HEVC/H.265,MVC,,WMV3,VC1,Motion JPEG,VP8,VP9,RV30/RV40.
Supernova Multimedia Spec. - Audio
MPEG1/2 Layer1/2/3,AC3,EAC3, HEAAC,VORBIS,DTS,LPCM,IMA-ADPCM,MS-ADPCM, G711 A/mu-law,LBR (cook),FLAC,DTS LBR,DTS XLL,DRA.
Supernova Multimedia Spec. - Photo
JPEG,PNG,BMP,MPO,GIF.

Reference

Troubleshooting

If you have any problem, check the counter measures for each symptom listed below. The following symptoms may have been caused by inappropriate adjustment rather than actual malfunction of the unit. If the trouble persists, contact the Customer Care Centre, see back page for contact details.

Symptoms	Possible solutions
No power	Please check the power cord plugged in and that the power outlet works. Unplug the power cord and plug it in after 60 seconds and restart the TV.
No picture	Please check antenna connection. Station may be experiencing problems, please tune to another station. Please adjust the settings of contrast and brightness.
Good picture but no sound	Please increase the volume. Please check TV is under mute mode, press MUTE button on the remote control. Please check sound settings If external devices are being used, check their volumes are not set too low or turned off. If using AVI or Component inputs, please make sure cables are connected properly and not loose. If using DVI to HDMI cable, a separate audio cable is required. Make sure a headphone jack is not connected..
Good sound but abnormal color or no picture	Please check antenna connection and antenna condition. If using Component input, please check Component connections, incorrect or loose connections may cause colour problems or cause the screen to be blank.
No response to remote control	Batteries of remote control may have exhausted, if necessary, please change the batteries. Clean the remote control lens. The distance between LED TV and remote control should be within 8m, within recommended operating angle and path is free of obstructions.
Full screen flickering under VGA	V-HEIGHT value may be set too big, restart computer and enter safe mode, then set monitor parameters to correct value according to adjustment description.
Horizontal stripes under VGA	Sample phase may be deflected, adjust phase according to picture position.
Colored dots may be present on the screen	Although the LED screen is made with high-precision technology and 99.99% or more of the the pixels are effective, black dots may appear or bright points of light (red, blue, or green) may appear constantly on the LED screen. This is a structural property of the LED screen and not a malfunction.
Picture is breaking up	Keep the TV away from noisy electrical sources such as cars, hair dryers, welders, and all optional equipment. Electrical atmospheric interference such as local or distant lightning storms may cause picture to break up. When installing optional equipment, leave some space between the optional equipment and the TV. Check the antenna and connection. Keep the antenna away from any power or input/output cables.

Reference

Troubleshooting

After Auto Tuning only some channels are available	Check your area is covered by Digital Video Broadcasts. Try re-tuning or manually tuning missing channels. Check that you are using the correct antenna type - please see pg.16 'Antenna connection'.
Channel cannot be selected	Check if the channel has been blocked in the main menu settings.
USB not playing	Please check connecting USB cable and power supply is connected. Hard drive has not been formatted. Please make sure USB disk is compatible and the multimedia data formats are supported.
Picture is distorted, macroblock, small block, dots, pixelization, etc	Compression of video contents may cause distortion especially on fast moving pictures such as sports and action movies.
Noise from speaker	Check cable connections, make sure a video cable is not connected to an audio input. Low signal level may cause sound distortion.
TV turns off automatically	Check if the Off Timer or Sleep timer is turned on.
TV turns on automatically	Check if the On Timer is set to On in the Setup menu.
Picture is not shown in full screen	First check if it is caused by the input signal. Then try to adjust Zoom in Function menu.

Picture defects and the reason



Snowy Picture

Snowy picture is usually due to weak signal. Adjust antenna or install an antenna amplifier.



Double Image or Ghosts

Double images are usually caused by reflections from tall buildings. Adjust the direction of the antenna or raise it.

Ghosting may also occur when still pictures are displayed continuously. It may disappear after a few moments.



Radio Wave Interference

Wave patterns are moving on the screen, which are usually caused by nearby radio transmitters or short-wave receiving equipment.



High Temperature Electrothermal Interference

Diagonal or herringbone patterns appear on the screen or part of picture is missing. This is probably caused by high temperature electrothermal equipment in a nearby hospital.

Konic